





**Feature:**

- Mounts easy on round & square shaft (with option -8).
- External clutch for manual adjustments.
- Maintenance free.
- Position indicator.
- Fail safe by *Enerdrive System*<sup>1</sup> (on model 60 & 80).
- Auxiliary switches (on model 20 & 80).

SM000S  
SM020S  
SM060S  
SM080S  
SM100S  
SM120S  
SM160S  
SM200S  
SM220S  
SM260S

Technical Data	SM000S	SM020S	SM060S	SM080S	SM100S	SM200S	SM120S	SM160S	SM220S	SM260S
<b>Auxiliary switches</b>	No	Yes (2)	No	Yes (2)	No	No	Yes (2)	No	Yes (2)	No
<b>Fail safe - Enerdrive</b>	No		Yes		No			Yes	No	Yes
<b>Power consumption</b>	8 VA		20 VA Peak, 8 VA		8 VA			20 VA Peak 8 VA	8 VA	20 VA Peak 8 VA
<b>Power supply</b>	22 to 26 VAC or 28 to 32 VDC				110 to 130 VAC 50/60Hz	220 to 250 VAC 50/60Hz	110 to 130 VAC 50/60H		220 to 250 VAC 50/60Hz	
<b>Approvals</b>					 Class 2					
<b>Ingress protection</b>	IP22 equivalent to Nema type 2, IP54 equivalent to Nema type 3R if water tight inlet bushings (not supplied NEP617) are installed						IP22 equivalent to Nema type 2			
<b>Torque</b>	70 in.lb. [8 Nm] at rated voltage									
<b>Running time through 90°</b>	90 - 110 sec (Fail-safe 20-30 sec)									
<b>Electrical connection</b>	18 AWG [0.8 mm <sup>2</sup> ] minimum									
<b>Inlet bushing</b>	2 inlet bushing of 5/8 in [15.9 mm] & 7/8 in [22.2 mm]									
<b>Control signal</b>	2 to 10 VDC or 4 to 20 mA (factory set 2 to 10 VDC)									
<b>Angle of rotation</b>	0 to 90 degrees, mechanically adjustable (factory set with 90° stroke)									
<b>Direction of rotation</b>	Reversible, Clockwise (CW) or Counterclockwise (CCW) (factory set with CW direction)									
<b>Ambient temperature</b>	-22°F à +122°F [-30° C à +50° C]									
<b>Storage temperature</b>	-22°F to +122°F [-30° C to +50° C]									
<b>Relative Humidity</b>	5 to 95 % non condensing.									
<b>Weight</b>	3 lbs. [1.4 kg]									

**Warning: Do not press the clutch when actuator is powered**

**Dimensions**

Dimension	Inches	Metric (mm)	
<b>A</b>	1.50	38.1	
<b>B</b>	3.26	82.8	
<b>C</b>	6.60	167.5	
<b>D</b>	model 000, 060, 100 & 200	3.01	76.4
	model 020, 080, 120, 160, 220 & 260	3.72	94.5

**Caution**

We strongly recommend that all neptronic® products be wired to a separate transformer and that transformer shall service only neptronic® products. This precaution will prevent interference with, and/or possible damage to incompatible equipment.  
When multiple actuators are wired on a single transformer, polarity must be observed. Long wiring runs create voltage drop which may affect the actuator performance.

<sup>1</sup> Enerdrive System U.S.A. Patent #5,278,454

Mechanical installation

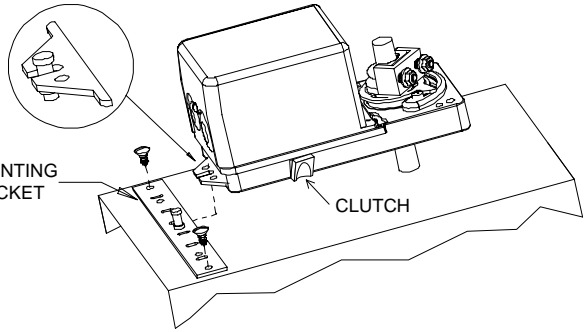

MOUNTING BRACKET



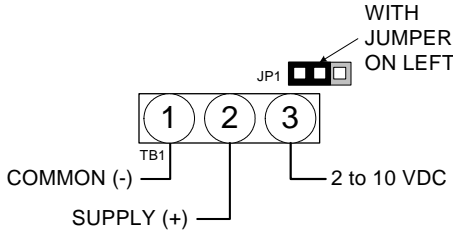
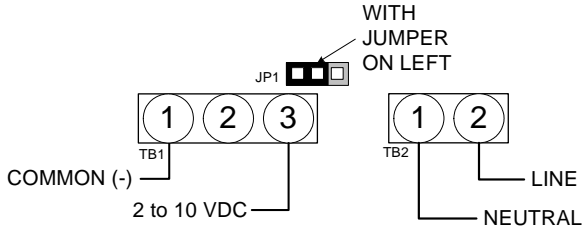
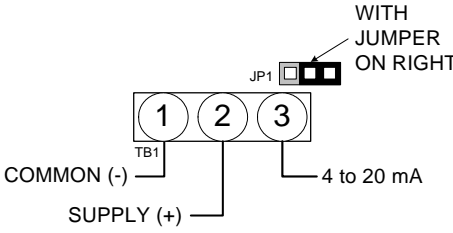
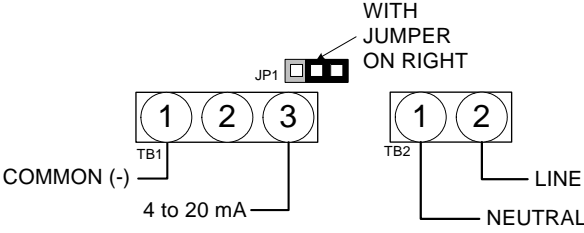

CLUTCH

1. Manually close the damper blades and positioned the actuator at 0° or 90°.
2. Slide the actuator onto the shaft.
3. Tighten the nuts on the “U” bolt to the shaft with a 8mm wrench to a torque of 60 in.lb. [6,7 Nm].
4. Slide the mounting bracket under the actuator. Ensure free movement of the slot at the base of the actuator. The bracket pin must be placed in the mid distance of the slot.
5. Fix the bracket to the ductwork with #8 self-tapping screws.

Wiring Diagrams

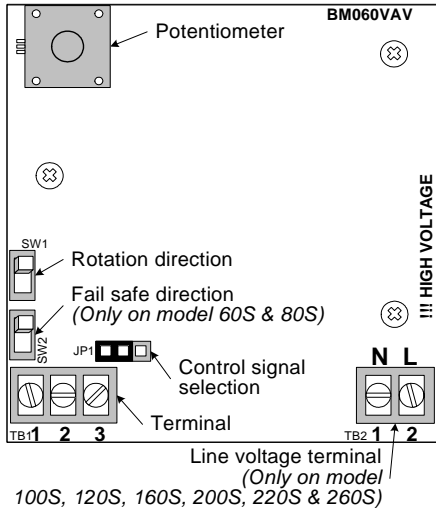
Models SM000S, 020S, 060S & 080S	Models SM100S, 120S, 160S, 200S, 220S & 260S
<p>2 to 10 VCC</p>  <p>WITH JUMPER ON LEFT</p> <p>COMMON (-) TB1</p> <p>SUPPLY (+)</p> <p>2 to 10 VDC</p>	<p>2 to 10 VCC</p>  <p>WITH JUMPER ON LEFT</p> <p>COMMON (-) TB1</p> <p>2 to 10 VDC</p> <p>LINE</p> <p>NEUTRAL</p>
<p>4 to 20 mA</p>  <p>WITH JUMPER ON RIGHT</p> <p>COMMON (-) TB1</p> <p>SUPPLY (+)</p> <p>4 to 20 mA</p>	<p>4 to 20 mA</p>  <p>WITH JUMPER ON RIGHT</p> <p>COMMON (-) TB1</p> <p>4 to 20 mA</p> <p>LINE</p> <p>NEUTRAL</p>

PC Board

 <p>Potentiometer BM060VAV</p> <p>Rotation direction SW1</p> <p>Fail safe direction (Only on model 60S &amp; 80S) SW2</p> <p>Control signal selection JP1</p> <p>Terminal TB1 1 2 3</p> <p>Line voltage terminal (Only on model 100S, 120S, 160S, 200S, 220S &amp; 260S) TB2 1 2</p> <p>!!! HIGH VOLTAGE</p>	<p>Dip switch settings</p> <p><b>Rotation direction (SW1)</b></p> <p>CW (0 to 90°) </p> <p>CCW (90 to 0°) </p> <hr/> <p><b>Fail safe direction (SW2)</b> (only on model 60 &amp; 80)</p> <p>Fail safe return at 0° </p> <p>Fail safe return at 90° </p>
---	---

Stroke adjustment

To adjust the stroke, move the adjustment screws at the desired position.