

Analog CPU Module Specifications

C0-02DR-D



4 DC Input/4 Relay Output; 2 Analog In/2 Analog Out Micro PLC

CLICK PLC CPU, 4 DC in / 4 relay out, 2-Ch Analog In / 2-Ch Analog out (current/voltage selectable), requires a 24 VDC power supply, 8K steps program memory, Ladder Logic programming, built-in RS232C programming port and RS232C Modbus/ASCII communications port (configurable up to 115.2K baud) and 3-wire RS485 Modbus/ASCII communications port. Real Time Clock/Calendar and battery backed memory. Discrete Inputs: 4 DC inputs, 24 VDC sink/source, 1 common. Discrete Outputs: 4 relay outputs, 6-240 VAC / 6-27 VDC Form A (SPST) relays, 1.0A/point, 1 common. Analog Inputs: 2 channels, 4-20 mA, 0-5 VDC. Analog Outputs: 2 channels, 4-20 mA, 0-5 VDC. Removable terminal block included.

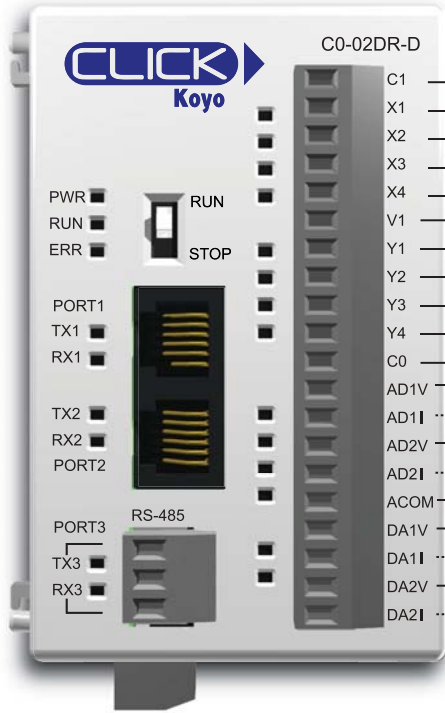

Wiring Diagram

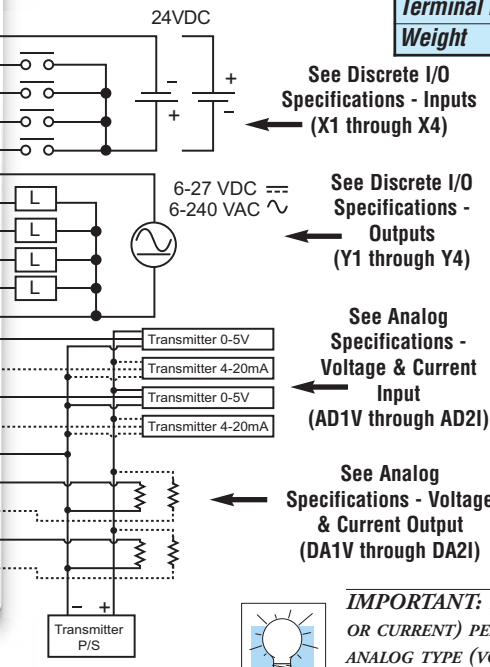

General Specifications	
Current Consumption at 24VDC	120 mA
Terminal Block Replacement Part No.	CO-16TB
Weight	5.6 oz (160 g)

Typical Relay Life (Operations) at Room Temperature	
Voltage & Load Type	Load Current: 1 A
30 VDC Resistive	300,000 cycles
30 VDC Solenoid	50,000 cycles
120 VAC Resistive	500,000 cycles
120 VAC Solenoid	200,000 cycles
ON to OFF = 1 cycle	



NOTE: WHEN USING ANALOG CPUS, YOU MUST ALSO USE CLICK PROGRAMMING SOFTWARE VERSION V1.10 OR LATER.



IMPORTANT: YOU CAN USE ONLY ONE TERMINAL (VOLTAGE OR CURRENT) PER CHANNEL. YOU MUST ALSO SELECT THE ANALOG TYPE (VOLTAGE OR CURRENT) IN THE CPU BUILT-IN I/O SETUP IN THE CLICK PROGRAMMING SOFTWARE (PULL-DOWN MENU SETUP > CPU BUILT-IN I/O SETUP).

X1 - X4

C0-02DR-D Discrete I/O Specifications - Inputs	
Inputs per Module	4 (Source/Sink)
Operating Voltage Range	24 VDC
Input Voltage Range	21.6 - 26.4 VDC
Input Current	X1-2: Typ 5 mA @ 24 VDC X3-4: Typ 4 mA @ 24 VDC
Input Impedance	X1-2: 4.7 kΩ @ 24 VDC X3-4: 6.8 kΩ @ 24 VDC
ON Voltage Level	X1-2: > 19 VDC X3-4: > 19 VDC
OFF Voltage Level	X1-2: < 4 VDC X3-4: < 7 VDC
Minimum ON Current	X1-2: 4.5 mA X3-4: 3.5 mA
Maximum OFF Current	X1-2: 0.1 mA X3-4: 0.5 mA
OFF to ON Response	X1-2: Typ 5 μs Max 20 μs* X3-4: Typ 2 ms Max 10 ms
ON to OFF Response	X1-2: Typ 5 μs Max 20 μs* X3-4: Typ 3 ms Max 10 ms
Status Indicators	Logic Side (4 points, green LED)
Commons	1 (4 points/common)

* Threshold level is 70% amplitude.

Equivalent Discrete Input Circuit

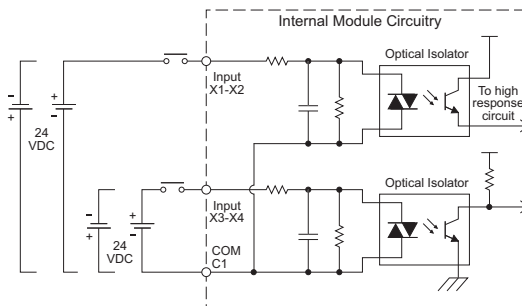

C0-02DR-D Temperature Derating Chart

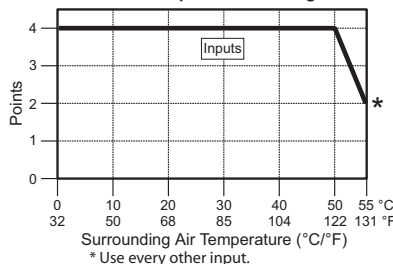

There are no ZipLink pre-wired PLC connection cables and modules for the analog CPUs. (Cannot mix discrete I/O and analog I/O signals in a ZIPLink cable.)

Analog CPU Module Specifications

C0-02DR-D (cont'd)

Y1 - Y4

C0-02DR-D Discrete I/O Specifications - Outputs	
Outputs per Module	4
Operating Voltage Range	6-27 VDC (-15%/+10%)/ 6-240 VAC (-10%/+10%)
Output Type	Relay, form A (SPST)
AC Frequency	47-63 Hz
Maximum Current	1 A/point (resistive)
Minimum Load Current	5 mA @ 5 VDC
Maximum Inrush Current	3 A for 10 ms
OFF to ON Response	< 15 ms
ON to OFF Response	< 15 ms
Status Indicators	Logic Side (4 points, red LED)
Commons per Module	1 (4 points/common)
Fuse	None

AD1V - AD2I

C0-02DR-D Analog Specifications - Voltage Input	
Number of Channels	2 (voltage/current selectable)
Input Range	0 - 5 VDC
Resolution	12 bit
Conversion Time	50 ms
Input Impedance	150 kΩ
Input Stability	±2 LSB maximum
Full-Scale Calibration Error	±1.2% maximum
Offset Calibration Error	±5 mV maximum
Accuracy vs. Temperature Error	±100 ppm / °C maximum

Analog Voltage Input Circuit

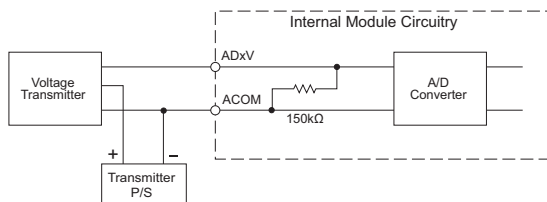

DA1V - DA2I

C0-02DR-D Analog Specifications - Voltage Output	
Outputs per Module	2 (voltage/current selectable)
Output Range	0 - 5 VDC
Resolution	12 bit
Conversion Time	1 ms
Load Impedance	2 kΩ minimum (output current 2.5 mA maximum)
Full-Scale Calibration Error	±0.8% maximum
Offset Calibration Error	±5 mV maximum
Accuracy vs. Temperature Error	±100 ppm / °C maximum

Analog Voltage Output Circuit

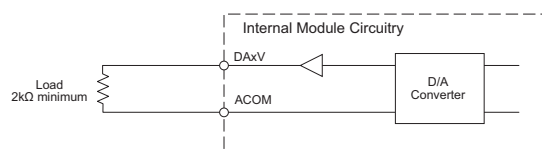

Equivalent Output Circuit

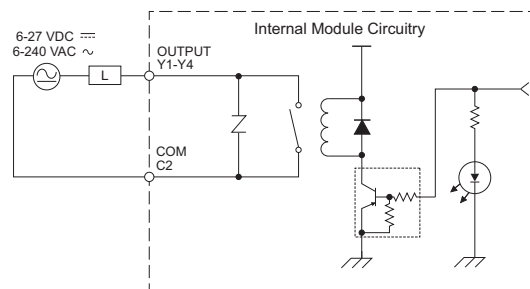

This circuit does not contain built-in protection.
Install protection elements such as a fuse outside the module if necessary.

C0-02DR-D Temperature Derating Chart

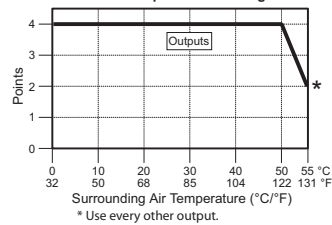

C0-02DR-D Analog Specifications - Current Input	
Inputs per Module	2 (voltage/current selectable)
Input Range	4 - 20 mA
Resolution	12 bit
Conversion Time	50 ms
Input Impedance	200 Ω
Input Stability	±2 LSB
Full-Scale Calibration Error	±1% maximum
Offset Calibration Error	±0.1 mA maximum
Accuracy vs. Temperature Error	±100 ppm / °C maximum

Analog Current Input Circuit

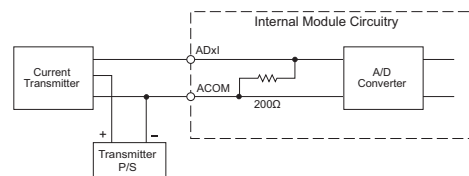

C0-02DR-D Analog Specifications - Current Output	
Outputs per Module	2 (voltage/current selectable)
Output Range	4 - 20 mA
Resolution	12 bit
Conversion Time	1 ms
Loop Supply Voltage	DC 18 - 30 V
Load Impedance	250Ω Load Power Supply: DC 18V: 600Ω maximum DC 24V: 900Ω maximum DC 30V: 1200Ω maximum
Full-Scale Calibration Error	±1% maximum
Offset Calibration Error	±0.1 mA maximum
Accuracy vs. Temperature Error	±100 ppm / °C maximum

Analog Current Output Circuit

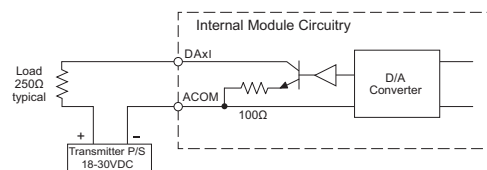

CLICK Specifications

General Specifications For All CLICK PLC Products

These general specifications apply to all CLICK CPUs, optional I/O modules, and optional power supply products. Please refer to the appropriate I/O temperature derating charts under both the CPU and I/O module specifications to determine best operating conditions based on the ambient temperature of your particular application.

General Specifications	
Power Input Voltage Range	20-28 VDC
Maximum Power Consumption	5 W (No 5 V use from communication port)
Maximum Inrush Current	30 A (less than 1ms)
Acceptable External Power Drop	Max 10 ms
Operating Temperature	32°F to 131°F (0°C to 55°C), IEC 60068-2-14 (Test Nb, Thermal Shock)
Storage Temperature	-4°F to 158°F (-20°C to 70°C) IEC 60068-2-1 (Test Ab, Cold) IEC 60068-2-2 (Test Bb, Dry Heat) IEC 60068-2-14 (Test Na, Thermal Shock)
Ambient Humidity	30% to 95% relative humidity (non-condensing)
Environmental Air	No corrosive gases. Environmental pollution level is 2 (UL840)
Vibration	MIL STD 810C, Method 514.2, EC60068-2-6 JIS C60068-2-6 (Sine wave vibration test)
Shock	MIL STD 810C, Method 516.2, IEC60068-2-27, JIS C60068-2-27
Noise Immunity	Comply with NEMA ICS3-304, Impulse noise 1 μ s, 1000V EN61000-4-2 (ESD), EN61000-4-3 (RFI), EN61000-4-4 (FTB) EN61000-4-5 (Surge), EN61000-4-6 (Conducted) EN61000-4-8 (Power frequency magnetic field immunity) RFI: No interference measured at 150, 450 MHz (5w/15cm)
Emissions	EN55011:1998 Class A
Agency Approvals	UL508 (File No. E157382, E316037); CE (EN61131-2)
Other	RoHS instruction conformity

Field I/O

Software

C-more & other HMI

AC Drives

AC Motors

Power Transmiss.

Steppers/Servos

Motor Controls

Proximity Sensors

Photo Sensors

Limit Switches

Encoders

Current Sensors

Pressure Sensors

Temp. Sensors

Pushbuttons/Lights

Process

Relays/Timers

Comm.

Terminal Blocks & Wiring

Power

Circuit Protection

Enclosures

Tools

Appendix

Part Index

CPU Module Specifications

These specifications apply to all the CPU modules.

	CPU Module Specifications	
	Basic CPU	Analog CPU
Control Method	Stored Program/Cyclic execution method	
I/O Numbering System	Fixed in Decimal	Fixed in Decimal
Ladder Memory (steps)	8000	8000
Total Data Memory (words)	8000	8000
Contact Execution (boolean)	< 0.6 μ s	< 0.6 μ s
Typical Scan (1k boolean)	1-2 ms	1-2 ms
RLL Ladder Style Programming	Yes	Yes
Run Time Edits	No	No
Scan	Variable / fixed	Variable / fixed
CLICK Programming Software for Windows	Yes	Yes
Built-in Communication Ports	Yes (two RS-232 ports)	Yes (2 RS-232 and 1 RS-485 ports)
FLASH Memory	Standard on CPU	Standard on CPU
Built-in Discrete I/O points	8 inputs, 6 outputs	4 inputs, 4 outputs
Built-in Analog I/O Channels	No	2 inputs, 2 outputs
Number of Instructions Available	21	21
Control Relays	2000	2000
System Control Relays	1000	1000
Timers	500	500
Counters	250	250
Interrupt	Yes (external: 8 / timed: 4)	Yes (external: 4 / timed: 4)
Subroutines	Yes	Yes
For/Next Loops	Yes	Yes
Math (Integer and Hex)	Yes	Yes
Drum Sequencer Instruction	Yes	Yes
Internal Diagnostics	Yes	Yes
Password Security	Yes	Yes
System Error Log	Yes	Yes
User Error Log	No	No
Memory Backup	Super Capacitor	Super Capacitor + Battery
Battery Backup	No	Yes (battery part no. D2-BAT-1)
Calendar/Clock	No	Yes
I/O Terminal Block Replacement	ADC p/n C0-16TB	ADC p/n C0-16TB
Communication Port & Terminal Block Replacement	N/A	ADC p/n C0-03TB
24 VDC Power Terminal Block Replacement	ADC p/n C0-4TB	ADC p/n C0-4TB

CLICK Specifications

CPU Features

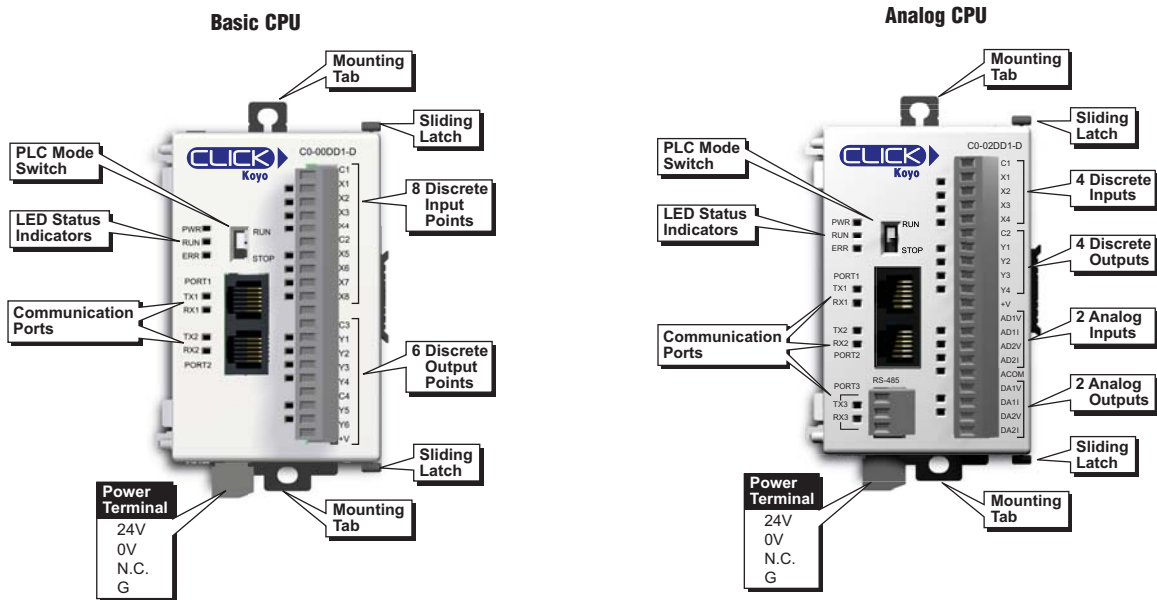

CPU LED Status Indicators

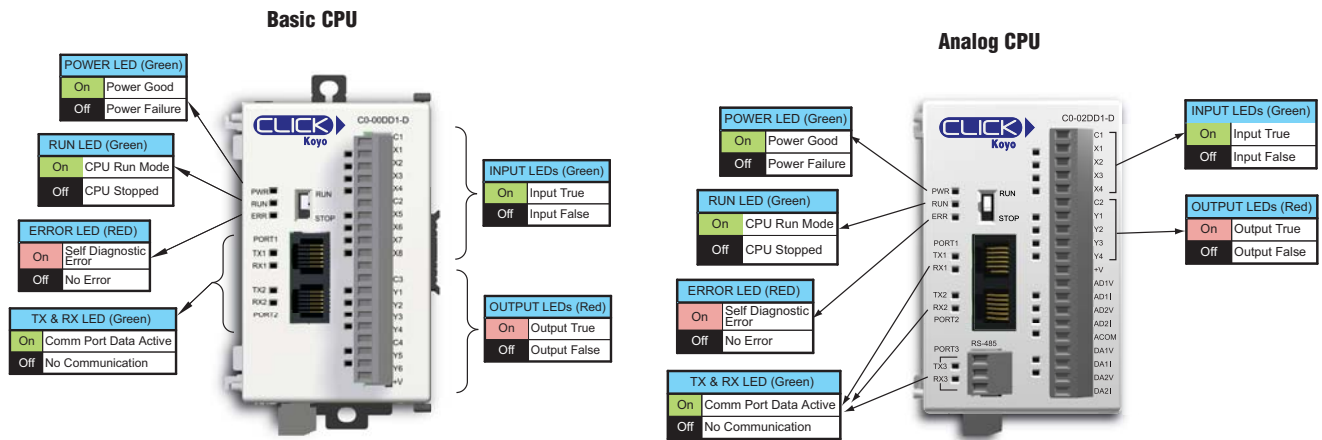

I/O Terminal Block Specifications for CPUs and I/O Modules

11-pin Terminal Block Specifications	
Connector Type	Pluggable Terminal Block
Number of Pins	11 pt
Pitch	3.50 mm
Wire Range	28-16 AWG
Wire Strip Length	7 mm
Screw Size	M2.0
Screw Torque	2.0 to 2.2 lb-inch
ADC Part Number	CO-8TB

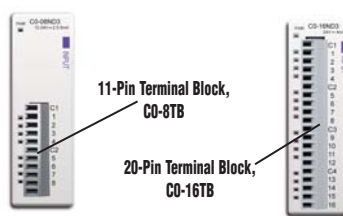

20-pin Terminal Block Specifications	
Connector Type	Pluggable Terminal Block
Number of Pins	20 pt
Pitch	3.50 mm
Wire Range	28-16 AWG
Wire Strip Length	7 mm
Screw Size	M2.0
Screw Torque	2.0 to 2.2 lb-inch
ADC Part Number	CO-16TB

Product Dimensions and Installation

It is important to understand the installation requirements for your CLICK system. Your knowledge of these requirements will help ensure that your system operates within its environmental and electrical limits.

Plan for Safety

This catalog should never be used as a replacement for the user manual.

You can purchase, download free, or view online the user manuals for these products. Manual CO-USER-M is the user manual for the CLICK PLC. This user manual contains important safety information that must be followed. The system installation should comply with all appropriate electrical codes and standards.

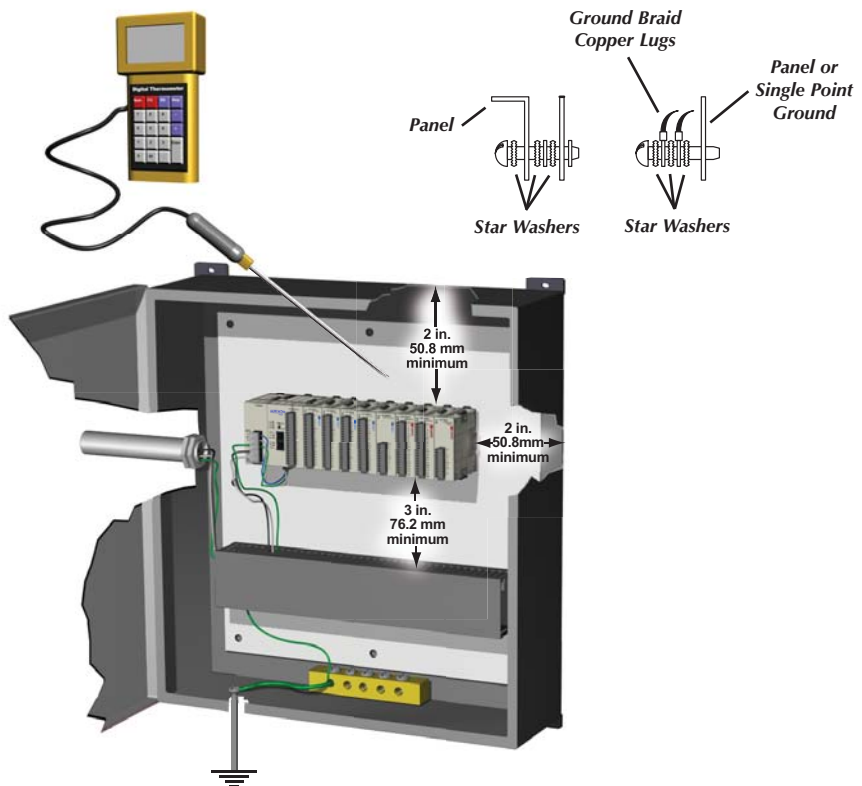

NOTE: THERE IS A MINIMUM CLEARANCE REQUIREMENT OF 2 INCHES (51 MM) BETWEEN THE CLICK PLC AND THE PANEL DOOR OR ANY DEVICES MOUNTED IN THE PANEL DOOR. THE SAME CLEARANCE IS REQUIRED BETWEEN THE PLC AND ANY SIDE OF THE ENCLOSURE. A MINIMUM CLEARANCE OF 3 INCHES (76 MM) IS REQUIRED BETWEEN THE PLC AND A WIREWAY OR ANY HEAT PRODUCING DEVICE.



Mounting Orientation

CLICK PLCs must be mounted properly to ensure ample airflow for cooling purposes. It is important to follow the unit orientation requirements and to verify that the PLC's dimensions are compatible with your application. Notice particularly the grounding requirements and the recommended cabinet clearances.

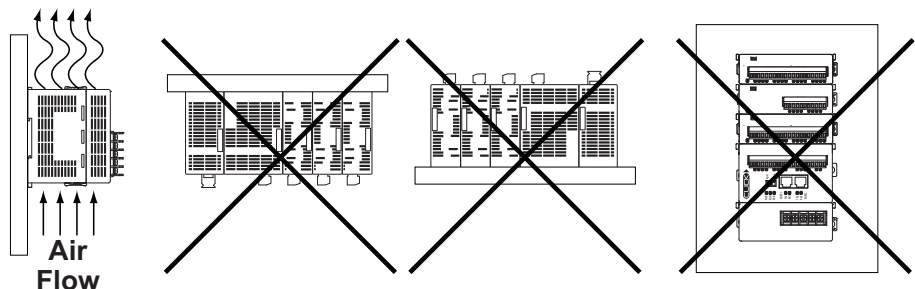

Product Dimensions and Installation

Connecting the Modules Together

CLICK CPUs, I/O modules and power supplies connect together using the extension ports that are located on the side panels of the modules (no PLC back-plane/base required).

1. Remove extension port covers and slide the latch tabs forward.
2. Align the module pins and connection plug, and press the I/O module onto the right side of the CPU.
3. Slide the latch tabs backward to lock the modules together.

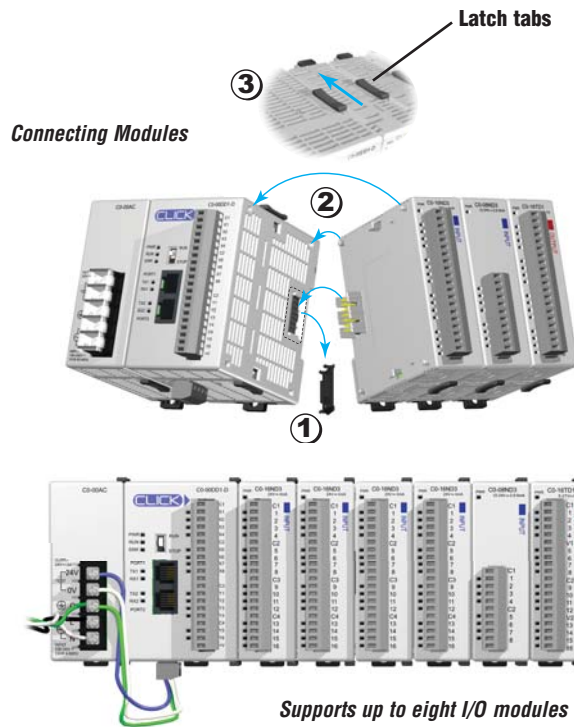

Mounting

The CLICK PLC system, which includes the CLICK power supplies, CPU modules, and I/O modules, can be mounted in one of two ways.

1. DIN rail mounted
2. Surface mounted using the built-in upper and lower mounting tabs.

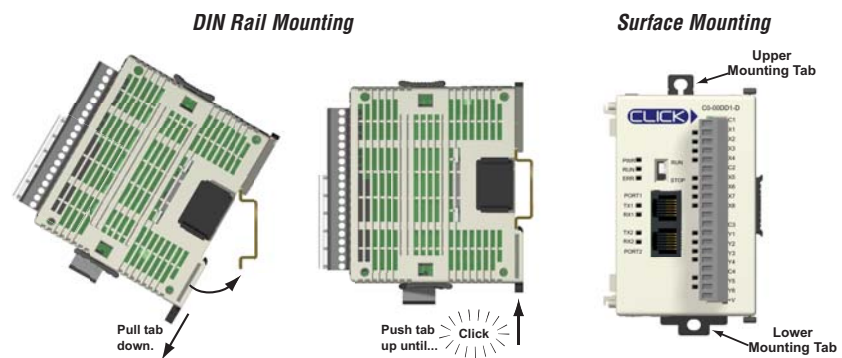

Unit Dimensions

These diagrams show the outside dimensions of the CLICK power supply, CPU, and I/O modules. The CLICK PLC system is designed to be mounted on standard 35mm DIN rail, or it can be surface mounted.

Allow proper spacing from other components within an enclosure.

Maximum system:

Power Supply + CPU + 8 I/O modules.

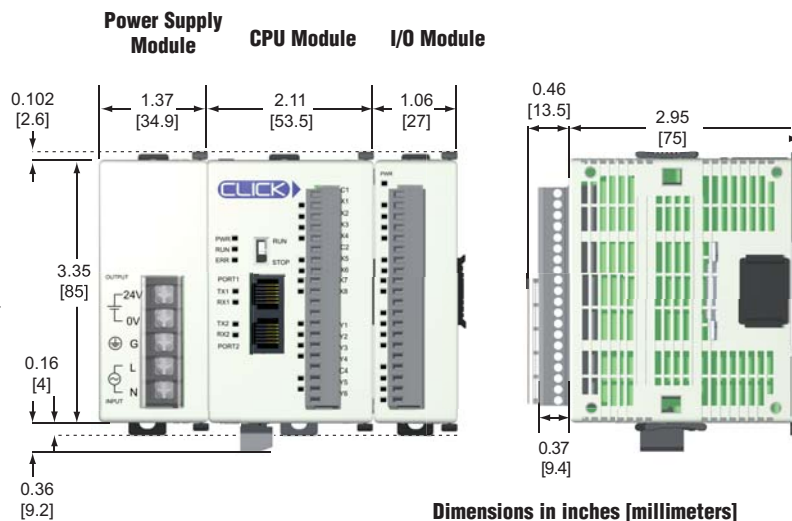

Product Dimensions and Installation

Unit Dimensions

Power Supply

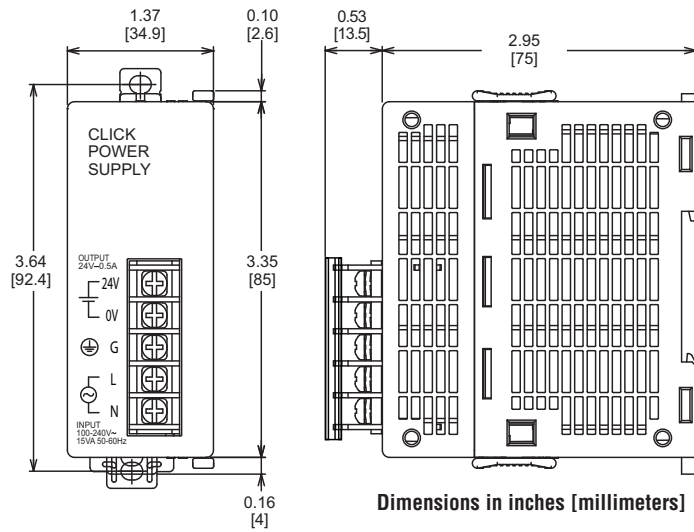

Dimensions in inches [millimeters]

CPU Module

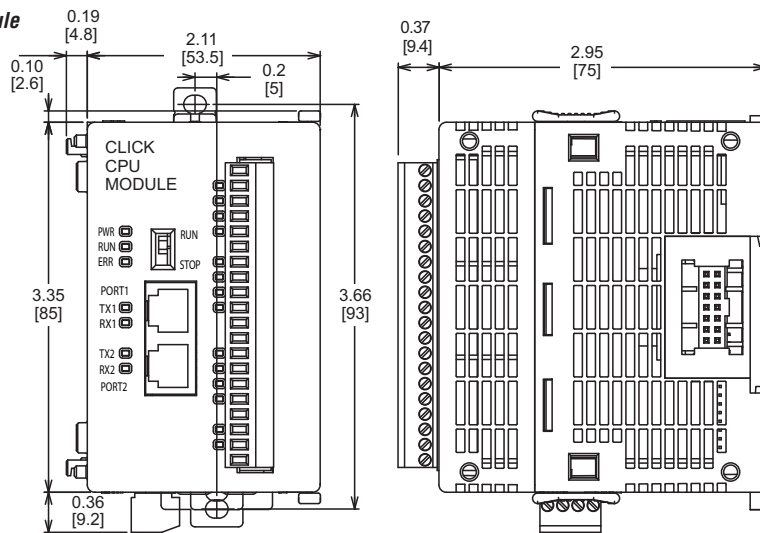

Dimensions in inches [millimeters]

I/O Module

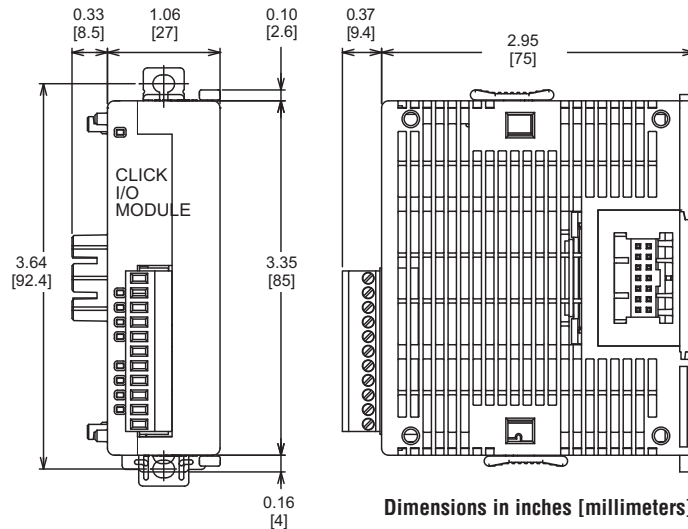

Dimensions in inches [millimeters]