

# IntesisBox<sup>®</sup>

for BACnet



General catalogue 2013

ENGLISH

your partner for **systems integration**

# Intesis



## General catalogue 2013

KNX · MODBUS · BACNET · LONWORKS · ENOCEAN · ASCII · OPC SERVER

**Intesis Software S.L.**

C/ Milà i Fontanals, 1 bis 1º  
08700 Igualada · Barcelona · Spain  
Tel. +34 93 804 71 34  
Fax +34 93 804 71 35  
info@intesis.com



# BACNET



# IntesisBox

## products for BACnet systems



BACnet is the Data Communication Protocol for Building Automation and Control Networks. Developed under the auspices of the American Society of Heating, Refrigerating and Air-Conditioning Engineers (ASHRAE), BACnet is an American national standard, a European standard, a national standard in more than 30 countries, and an ISO global standard. The protocol is supported and maintained by ASHRAE Standing Standard Project Committee 135.

For further information, please visit [www.bacnet.org](http://www.bacnet.org)

### IntesisBox BACnet gateway

**IntesisBox® IB0X-BAC-XXX gateways have been specially designed to allow supervision and bidirectional control of all the parameters and functionality of systems and equipment with KNX, ModBus, LonWorks and Fidelio systems from BACnet/IP networks.**

- Easy installation through TP (TP-1/FT-10), RS485, Ethernet or FIAS communication interfaces
- Great integration flexibility
- Advanced integration of KNX (light, control, blinds), Modbus and Lonworks (AC units) in BMS systems including Siemens, Honeywell, Trend, Delta Controls ... and also meters, PLC's, HMI, etc.

# BACNET

# PA-AC-BAC-64/128

IntesisBox® PA-AC-BAC-64 / 128 gateways have been specially designed, in collaboration with Panasonic, to allow monitoring and bidirectional control of all the parameters and functionality of Panasonic air conditioning ECOi and PACi indoor units from BACnet installations.

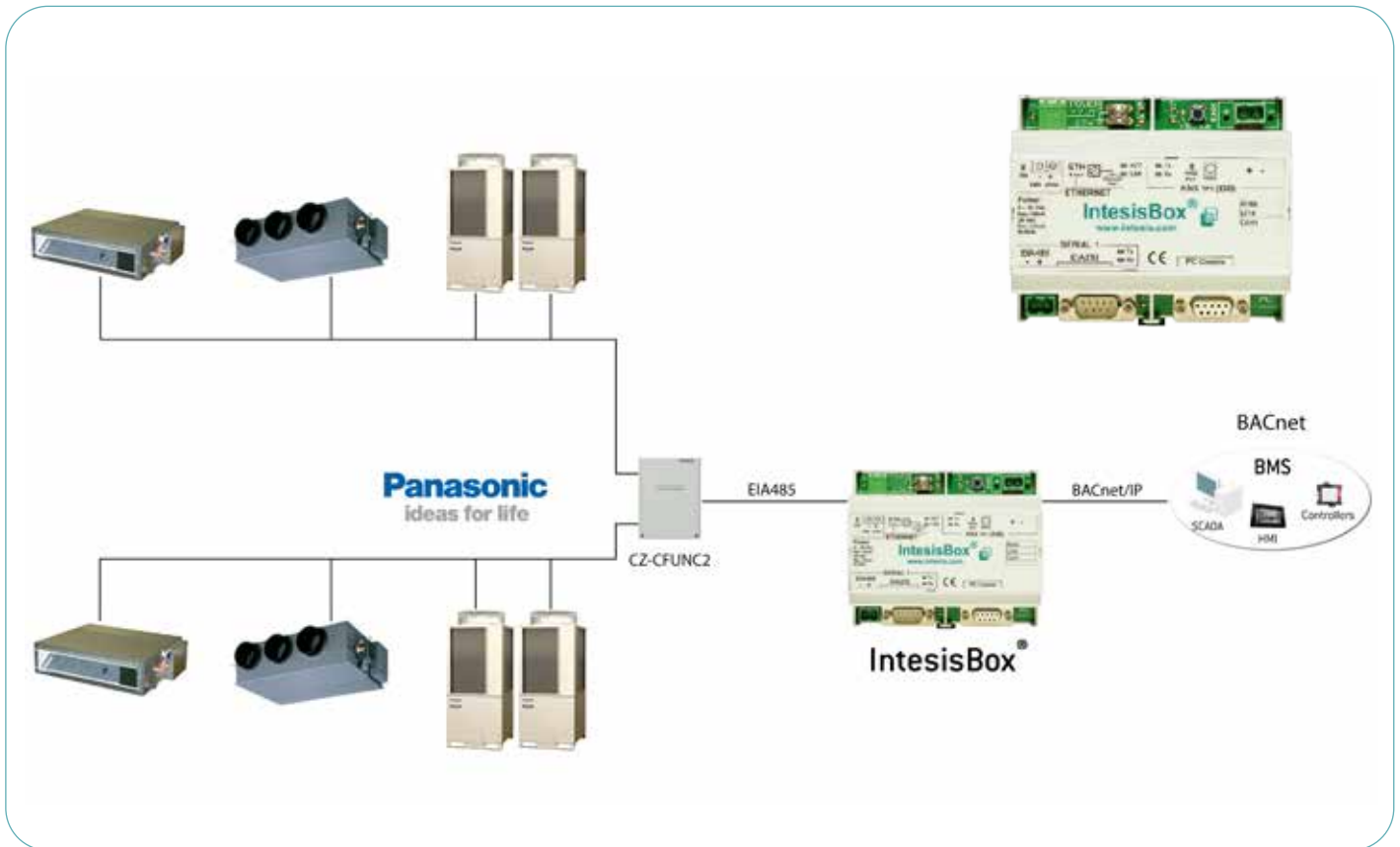

## Specifications

- Bidirectional: Monitoring and Control
- Robust and reliable hardware
- Direct connection to BACnet/IP
- Independent management of communications
- Power supply: 9 to 24Vdc or 24Vac
- Standard DIN-Rail 6 modules enclosure

## Models available

- PA-AC-BAC-64 (64 indoor units and 30 outdoor units)
- PA-AC-BAC-128 (128 indoor units and 30 outdoor units)

## Main features

- Easy installation. Connection of PANASONIC communication interface CZ-CFUNC2 to IntesisBox® through EIA485.
- Great integration flexibility. The gateway polls continuously or by means of BACnet subscription requests (COV). Panasonic indoor units can be monitored and controlled from BACnet using standard BACnet objects. IntesisBox BACnet/IP Server series are configured using LinkBoxBacnet software.
- Simultaneous control from BACnet/IP BMS and the Panasonic remote controller.

## Info

Datasheet: [http://www.intesis.com/pdf/IntesisBox\\_PA-AC-BAC-64-128\\_datasheet\\_eng.pdf](http://www.intesis.com/pdf/IntesisBox_PA-AC-BAC-64-128_datasheet_eng.pdf)

## IBOX-BAC-KNX

IntesisBox® IBOX-BAC-KNX gateway has been specially designed to allow monitoring and bidirectional control of KNX systems from BACnet/IP installations.

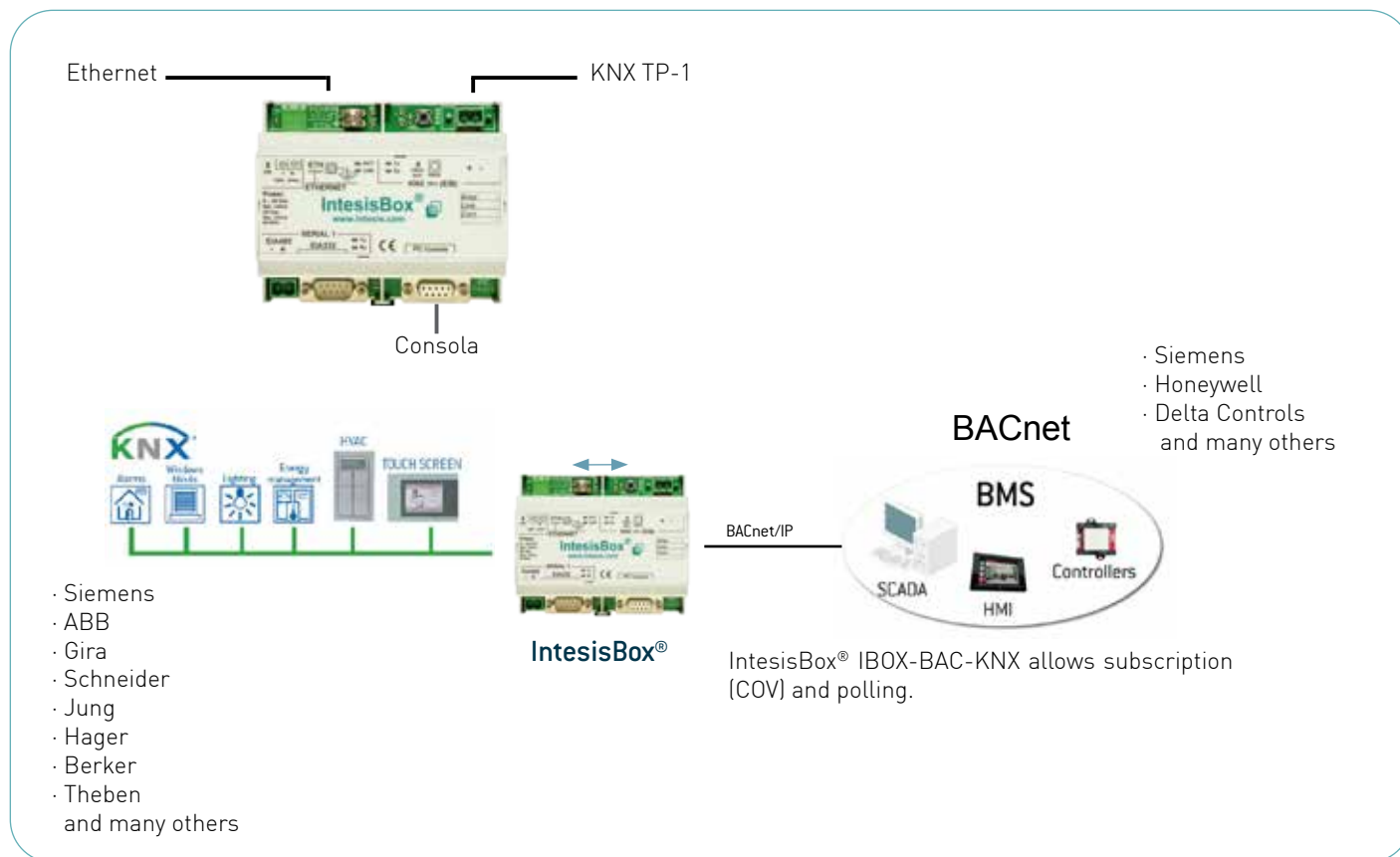

### Specifications

- Bidirectional: Monitoring and Control
- Robust and reliable hardware
- Direct connection to KNX and BACnet/IP network
- Independent management of communications
- Power supply: 9 to 24Vdc or 24Vac
- Standard DIN-Rail 6 modules enclosure

### Models available

- IBOX-BAC-KNX-100 (Maximum 100 control points)
- IBOX-BAC-KNX-A (Maximum 500 control points)
- IBOX-BAC-KNX-B (Maximum 3000 control points)

### Info

Datasheet: [http://www.intesis.com/pdf/IntesisBox\\_BACnet\\_IP\\_Server\\_KNX\\_datasheet\\_eng.pdf](http://www.intesis.com/pdf/IntesisBox_BACnet_IP_Server_KNX_datasheet_eng.pdf)

### Main features

- Easy installation. Direct connection to KNX twisted pair bus (TP-1)
- Easy and fast configuration with supplied software LinkBoxBAC.
- Great integration flexibility. The gateway is a BACnet/IP server. Reading done either by continuous polling or using subscription (COV). BACnet server series are configured with supplied software LinkBoxBAC.
- Advanced integration of KNX installations (light control, blinds, ...) in building management systems based in BACnet/IP (Siemens, Honeywell, Delta Controls, Trend, etc).

# IBOX-BAC-MBRTU / IBOX-BAC-MBTCP

IntesisBox® IBOX-BAC-MBRTU / MBTCP gateways have been specially designed to offer monitoring and bidirectional control for all the parameters and functionality of systems and equipment with ModBus connectivity from BACnet/IP installations.

## Modbus devices

### HVAC

- Air Conditioners
- Chillers
- thermostats
- Fan-coil controllers
- Automations

### Meters

- Electric meters
- Energy meters
- T<sup>a</sup> and Hr probes

### Automation

- B.M.S.
- PLC
- HMI
- and many others

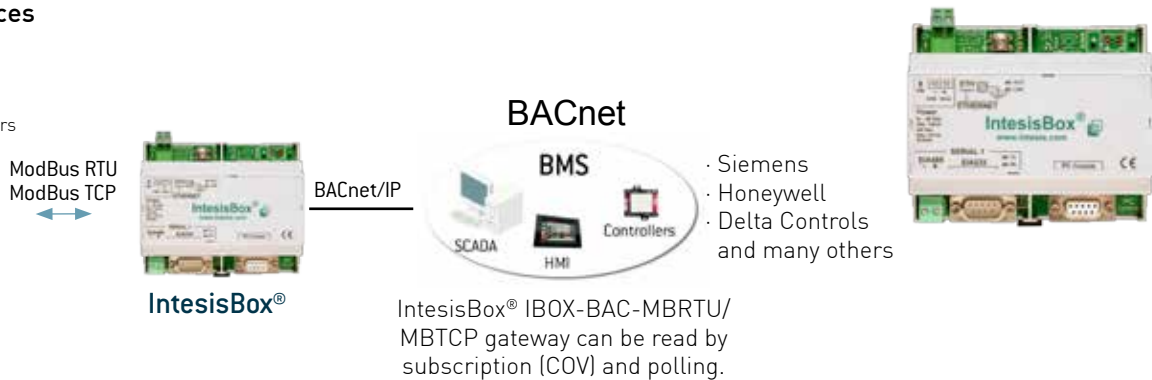

Integration example:  
Chillers with Modbus RTU.

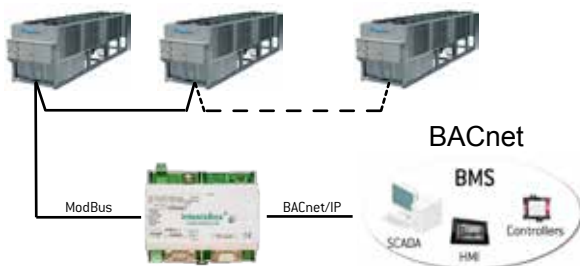

Integration example:  
ModBus RTU electricity meters.

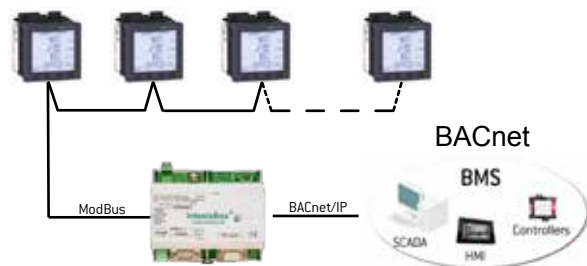

## Specifications

- Bidirectional: Monitoring and Control
- Robust and reliable hardware
- Direct connection to ModBus
- Independent management of communications
- Power supply: 9 to 24Vdc or 24Vac
- Standard DIN-Rail 6 modules enclosure

## Models available

- IBOX-BAC-MBRTU-100 (Max. 100 control points / 254 ModBus RTU slave devices)
- IBOX-BAC-MBRTU-A (Max. 500 control points / 254 ModBus RTU slave devices)
- IBOX-BAC-MBRTU-B (Max. 3000 control points / 254 ModBus RTU slave devices)
- IBOX-BAC-MBTCP-100 (Max. 100 control points / 6 ModBus TCP slave devices)

## Info

Datasheet: [http://www.intesis.com/pdf/IntesisBox\\_BACnet\\_IP\\_server\\_Modbus\\_RTU\\_master\\_datasheet\\_eng.pdf](http://www.intesis.com/pdf/IntesisBox_BACnet_IP_server_Modbus_RTU_master_datasheet_eng.pdf)

Datasheet: [http://www.intesis.com/pdf/IntesisBox\\_BACnet\\_IP\\_server\\_Modbus\\_TCP\\_master\\_datasheet\\_eng.pdf](http://www.intesis.com/pdf/IntesisBox_BACnet_IP_server_Modbus_TCP_master_datasheet_eng.pdf)

- IBOX-BAC-MBTCP-A (Maxi. 500 control points / 6 ModBus TCP slave devices)
- IBOX-BAC-MBTCP-B (Max. 3000 control points / 6 ModBus TCP slave devices)

## Main features

- Easy installation. Direct connection to ModBus devices through RS485 (2 wire) (IBOX-BAC-MBRTU) and Ethernet (IBOX-BAC-MBTCP).
- Great integration flexibility. The IntesisBox® ModBus Master interface reads continuously by polling the configured ModBus slave devices. Read values kept in IntesisBox® memory to be used when needed by the BACnet/IP system. Reads done by polling or subscription (COV).
- Advanced integration of HVAC systems with Modbus interface from BACnet/IP like Ciatesa, Hitecsa, Lennox, Carrier, etc. and meters, PLC's , HMI, etc.

## IBOX-BAC-LON

IntesisBox® IBOX-BAC-LON gateway has been specially designed to allow monitoring and bidirectional control of all the parameters and functionality of systems and equipment with LonWorks® connectivity from BACnet/IP installations.

### LonWorks® devices

#### HVAC

- Air Conditioners
- Chillers
- Thermostats
- Fan-coil controllers

#### Meters

- Electric meters
- Energy meters
- T<sup>a</sup> and Hr probes

#### Automation

- B.M.S.
- PLC
- HMI
- and many others

LON TP/FT-10



IntesisBox®

BACnet/IP

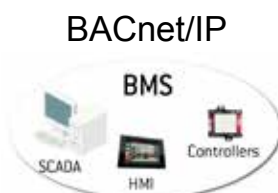

IntesisBox® IBOX-BAC-LON gateway can be read by subscription (COV) and polling.

- Wonderware
- Intellution
- ABB
- and many others



Integration example:  
VRV DAIKIN equipped with LON gateway.

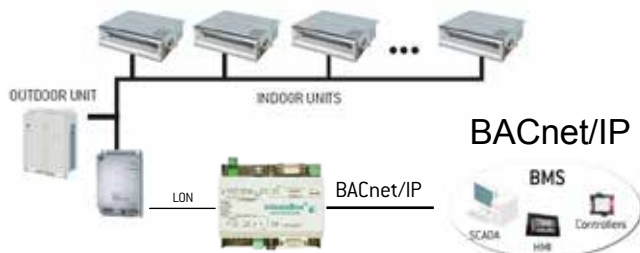

Integration example:  
LON Fan-coil controllers.

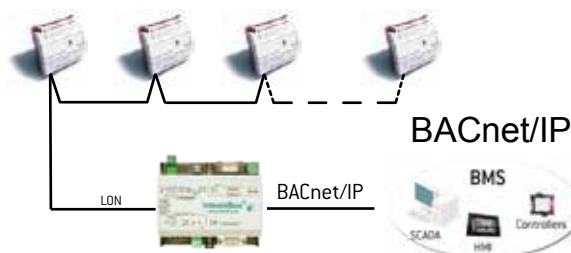

### Specifications

- Bidirectional: Monitoring and Control
- Robust and reliable hardware
- Direct connection to LON and BACnet/IP
- Independent management of communications
- Power supply: 9 to 24Vdc or 24Vac
- Standard DIN-Rail 6 modules enclosure

### Models available

- IBOX-BAC-LON-100 (Maximum 100 control points and 64 LON devices)
- IBOX-BAC-LON-A (Maximum 500 control points and 64 LON devices)
- IBOX-BAC-LON-B (Maximum 3000 control points and 128 LON devices)

### Info

Datasheet: [http://www.intesis.com/pdf/IntesisBox\\_BACnet\\_IP\\_Server\\_LON\\_datasheet\\_eng.pdf](http://www.intesis.com/pdf/IntesisBox_BACnet_IP_Server_LON_datasheet_eng.pdf)

### Main features

- Easy installation. Direct connection to LONWorks devices through TP/FT-10 (2 wire) connection
- Great integration flexibility. Thanks to LinkBoxBAC supplied software. No bindings needed thanks to continuous polling readout. Access through physical address (Neuron-Id) or subnet node (commissioned devices) possible. LonMaker not required.
- Advanced integration for centralized AC systems equipped with Lonworks interfaces in BACnet/IP (Siemens, Honeywell, Delta Controls, Trend,...), also integrating fan-coil controllers, meters, PLCs, HMI, etc.



# IBOX-BAC-FIDELIO\_IP

IntesisBox® IBOX-BAC-FIDELIO gateway has been specially designed to offer monitoring of MICROS FIDELIO hotel management systems from BACnet/IP installations.



## Fidelio hotel management system



Supervision of Check IN/Check OUT states up to 1.500 rooms.

ETHERNET



IntesisBox®

BACnet/IP

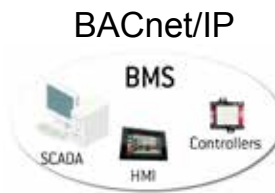

IntesisBox® IBOX-BAC-FIDELIO gateway can be read by subscription (COV) and polling.

- Siemens
- Honeywell
- Delta Controls and many others

## Specifications

- Bidirectional: Monitoring and Control
- Robust and reliable hardware
- Direct connection to BACnet/IP
- Independent management of communications
- Power supply: 9 to 24Vdc or 24Vac
- Standard DIN-Rail 6 modules enclosure

## Main features

- Easy installation. Connection trough Ethernet to the Fidelio system through the FIAS communication interface.
- Great integration flexibility. IntesisBox® FIDELIO read values check IN/OUT states up to 1500 rooms. Read values kept in IntesisBox® memory to be used when needed by the BACnet/IP system. Reads in BACnet/IP side done by polling or subscription (COV). IntesisBox BACnet/IP gateways are configured by supplied software LinkBoxBAC.
- Advanced integration of Fidelio hotel management in any BACnet/IP based system , like Siemens, Honeywell, delta Controls, Trend , ...]

## Info

Datasheet: [http://www.intesis.com/pdf/IntesisBox\\_BACnet\\_IP\\_Server\\_Fidelio\\_datasheet\\_eng.pdf](http://www.intesis.com/pdf/IntesisBox_BACnet_IP_Server_Fidelio_datasheet_eng.pdf)

## IBOX-BAC-MBUS

IntesisBox® IBOX-BAC-MBUS gateway has been specially designed to monitor all the registers of M-BUS meters from BACnet/IP installations.

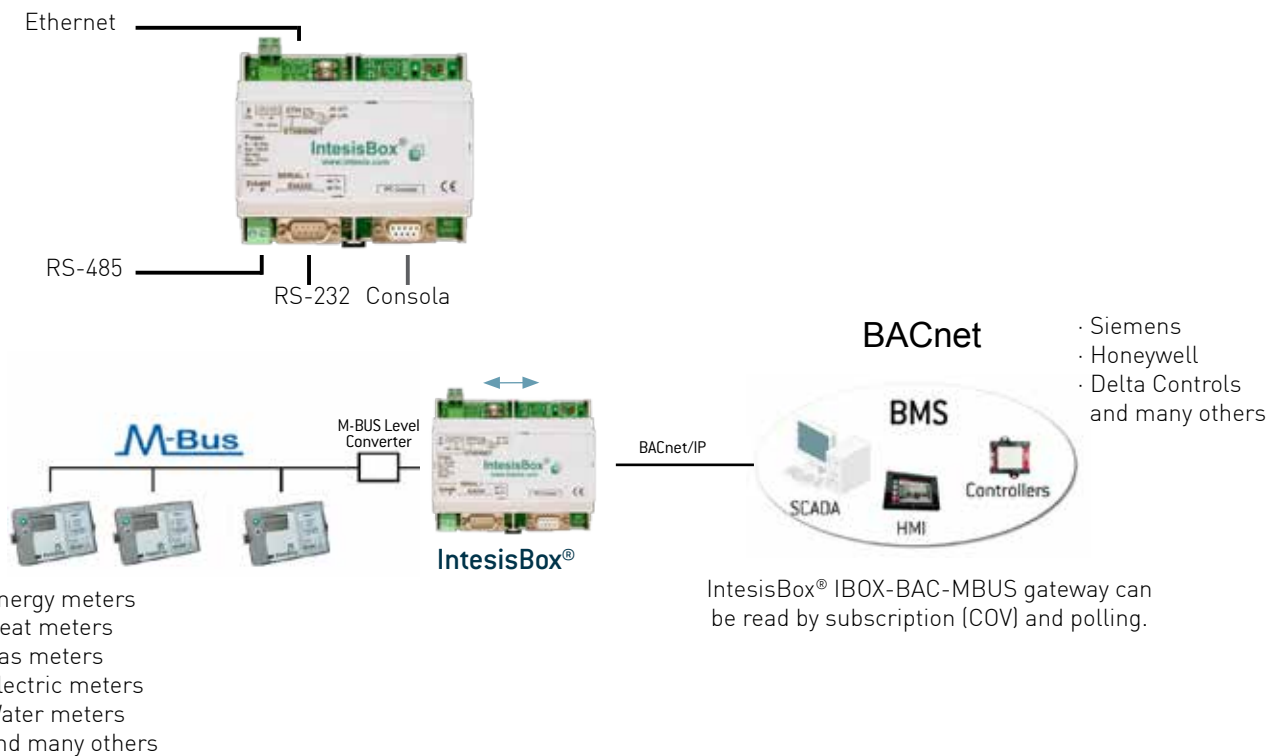

### Specifications

- Bidirectional: Monitoring and Control
- Robust and reliable hardware
- Direct connection to BACnet/IP
- Independent management of communications
- Power supply: 9 to 24Vdc or 24Vac
- Standard DIN-Rail 6 modules enclosure

### Models available

- IBOX-BAC-MBUS-100 (Maximum 100 control points and 10 devices)
- IBOX-BAC-MBUS-A (Maximum 600 control points and 60 devices)
- IBOX-BAC-MBUS-B (Maximum 2000 control points and 500 devices)

### Info

Datasheet: [http://www.intesis.com/pdf/IntesisBox\\_BACnet\\_IP\\_server\\_M-Bus\\_datasheet\\_eng.pdf](http://www.intesis.com/pdf/IntesisBox_BACnet_IP_server_M-Bus_datasheet_eng.pdf)

### Main features

- Easy installation. Connection to M-Bus system with an external level converter M-Bus RS232 or RS485; at the other side it communicates with the Monitoring/control system with BACnet/IP protocol.
- Easy and fast configuration of the gateway with supplied software LinkBoxBAC.
- Great integration flexibility. The gateway polls continuously or only when ordered from the BACnet/IP side, updating internal memory ready to be read by polling or subscription from the BACnet/IP side.
- Advanced integration. Enables full and transparent Monitoring of M-Bus installations (energy meters, gas meters, etc.) from BACnet/IP based BMS systems (Siemens, Honeywell, Delta Controls, Trend ...).

# IBOX-BAC-DALI

IntesisBox® IBOX-BAC-DALI gateway has been specially designed to allow monitoring and bidirectional control of DALI ballasts from BACnet/IP installations.

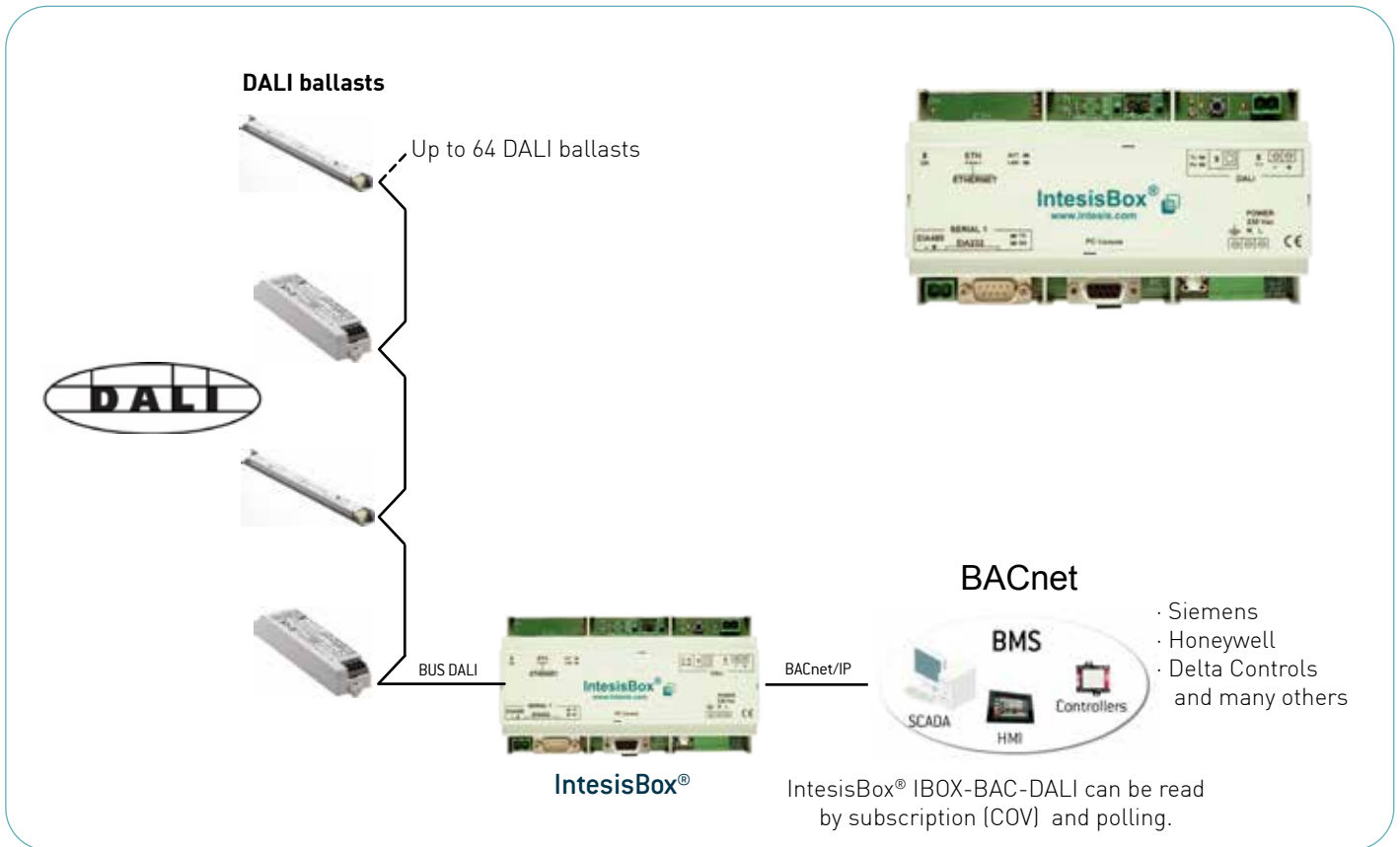

## Specifications

- Bidirectional: Monitoring and Control
- Robust and reliable hardware
- Up to 64 DALI ballasts integration
- Direct connection to DALI and BACnet/IP
- DALI power supply included
- Mains Power at 230 Vac
- Standard DIN-Rail 9 modules enclosure

## Main features

- Easy installation. Direct connection using 2 wires to the DALI ballasts.
- Great integration flexibility. IntesisBox® IBOX-BAC-DALI is a DALI Master that reads/writes ballasts connected to the bus. IntesisBox BACnet server gateways are configured by supplied software LinkBoxBAC.
- Advanced integration of DALI ballasts: digital control of power level (dimming), error condition detections reporting, etc.

## Info

Datasheet: [http://www.intesis.com/pdf/IntesisBox\\_BACnet\\_IP\\_Server\\_DALI\\_datasheet\\_eng.pdf](http://www.intesis.com/pdf/IntesisBox_BACnet_IP_Server_DALI_datasheet_eng.pdf)

## IBOX-BAC-SUNWAYS

IntesisBox® IBOX-BAC-SUNWAYS gateway has been specially designed to allow monitoring of all the operating parameters of SUNWAYS NT Series inverters (photovoltaic) from any BACnet installation.

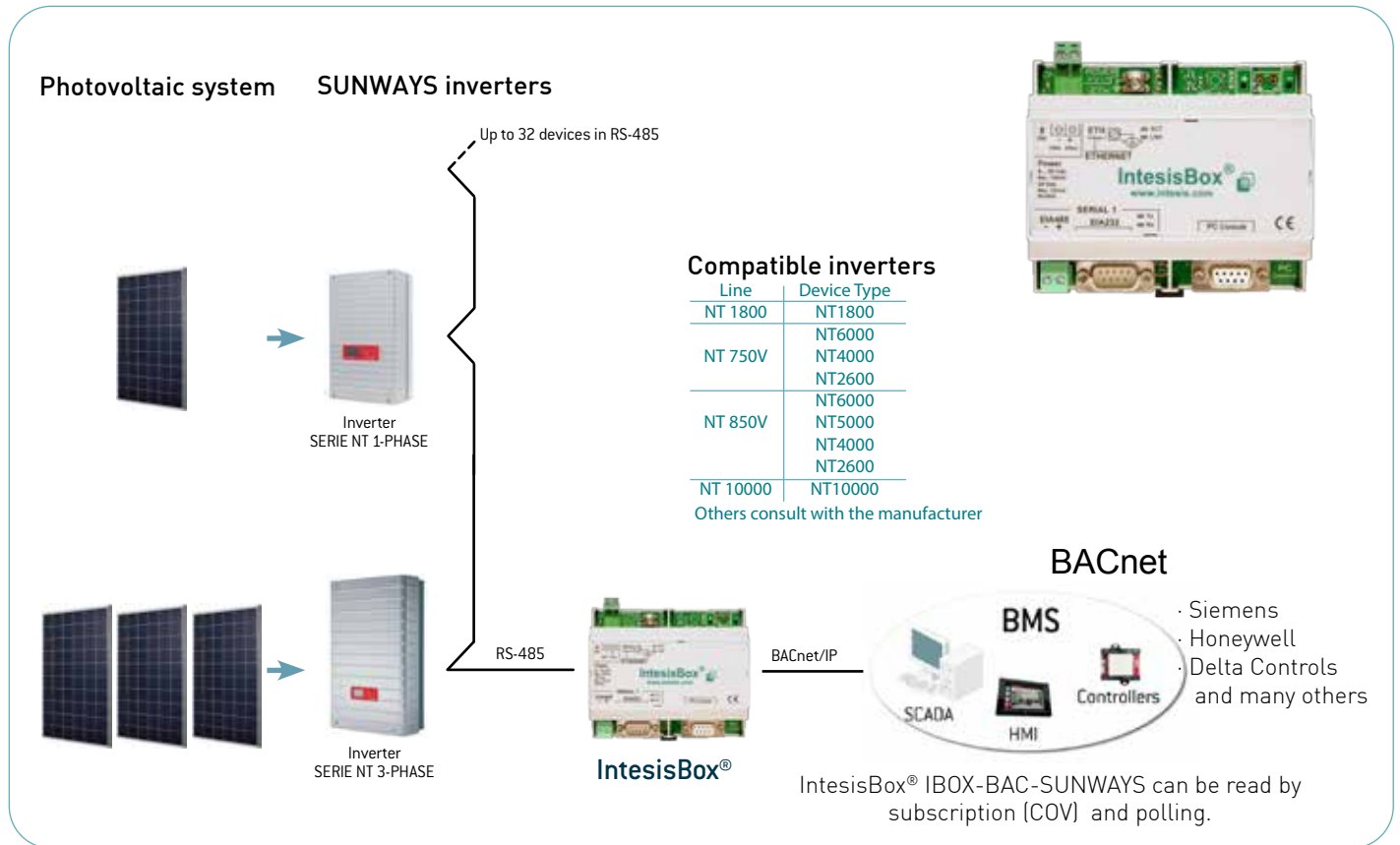

### Specifications

- Bidirectional: Monitoring and Control
- Robust and reliable hardware
- Direct connection to RS485 and BACnet/IP
- Independent management of communications
- Power supply: 9 to 24Vdc or 24Vac
- Standard DIN-Rail 6 modules enclosure

### Main features

- Easy installation. Direct connection using 2 wires (RS485) to SUNWAYS devices.
- Great integration flexibility. IntesisBox® SUNWAYS reads continuously by polling SUNWAYS devices making read values available when needed by polling or subscription (COV). IBOX-BAC-SUNWAYS shows SUNWAYS devices as BACnet devices. IntesisBox unit is configured by supplied LinkBoxBac software.
- Advanced integration of the photovoltaic collection system of SUNWAYS in any control system based in BACnet/IP like Siemens, Honeywell, delta Controls, Trend, etc

### Info

Datasheet: [http://www.intesis.com/pdf/IntesisBox\\_BACnet\\_IP\\_Server\\_Sunways\\_datasheet\\_eng.pdf](http://www.intesis.com/pdf/IntesisBox_BACnet_IP_Server_Sunways_datasheet_eng.pdf)

# IBOX-BAC-NID3000

IntesisBox® IBOX-BAC-NID3000, gateway has been specially designed to offer monitoring and bidirectional control of the operating parameters of Notifier ID3000 and ID3002 Series fire panels from BACnet/IP installations.

Integration example:  
Fire panel Notifier ID series with IBOX-BAC-NID3000



Notifier ID3000  
Notifier ID3002

RS-232



IntesisBox®

BACnet/IP

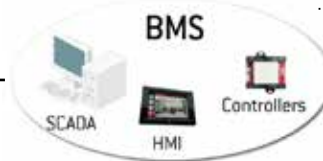

BACnet

- Siemens
- Honeywell
- Delta Controls and many others

IntesisBox® IBOX-BAC-NID3000 can be read by subscription (COV) and polling.

## Specifications

- Bidirectional: Monitoring and Control
- Robust and reliable hardware
- Direct connection to RS-232 and BACnet/IP
- Independent management of communications
- Power supply: 9 to 24Vdc or 24Vac
- Standard DIN-Rail 6 modules enclosure

## Main features

- Easy installation. Direct connection using a RS-232 cable to main board or optional ISO-RS232 of the fire panel
- Great integration flexibility. IntesisBox® has a fix map of variables allowing a simple integration of the fire panel. All the read values are kept in the IntesisBox® memory to be read by polling or subscription (COV) from the BACnet side. IntesisBox® BACnet server series gateways are configured with the supplied LinkBoxBAC software
- Advanced integration of Notifier fire panels in control systems based in BACnet/IP like Siemens, Honeywell, delta Controls, Trend, etc

## Info

Datasheet: [http://www.intesis.com/pdf/IntesisBox\\_BACnet\\_IP\\_Server\\_NID3000\\_datasheet\\_eng.pdf](http://www.intesis.com/pdf/IntesisBox_BACnet_IP_Server_NID3000_datasheet_eng.pdf)

## IBOX-MBS-BAC

IntesisBox® IBOX-MBS-BAC gateway have been specially designed, to allow monitoring and bidirectional control of all the parameters and functionality of systems and devices with BACnet/IP connectivity from ModBus installations.



### BACnet devices

- HVAC**
- Air Conditioners
  - Chillers
  - thermostats
  - Fan-coil controllers
  - Automations

- Meters**
- Electric meters
  - Energy meters
  - T° and Hr probes

- Automation**
- B.M.S.
  - PLC
  - HMI
  - and many others

BACnet/IP



IntesisBox®

ModBus RTU  
ModBus TCP

### Modbus



Modbus Server (Slave) TCP o RTU (RS485/RS232) software selectable

- Wonderware
- Intellution
- ABB
- and many others

Integration example:  
AC VRV DAIKIN equipped with BACnet gateway.

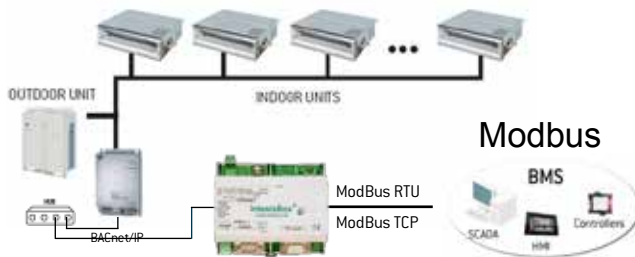

Integration example:  
Fan-coil BACnet/IP controllers.

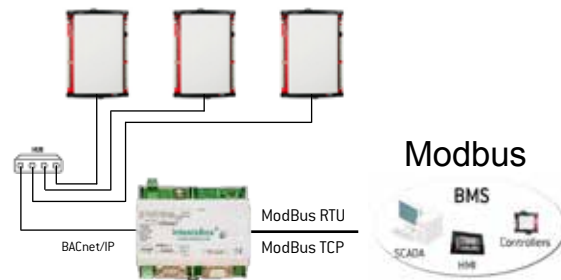

### Specifications

- Bidirectional: Monitoring and Control
- Robust and reliable hardware
- Direct connection to BACnet and ModBus
- Independent management of communications
- Power supply: 9 to 24Vdc or 24Vac
- Standard DIN-Rail 6 modules enclosure

### Models available

- IBOX-MBS-BAC-100 (Maximum 100 control points and 16 BACnet/IP devices)
- IBOX-MBS-BAC-A (Maximum 500 control points and 16 BACnet/IP devices)
- IBOX-MBS-BAC-B (Maximum 3000 control points and 16 BACnet/IP devices)

### Info

Datasheet: [http://www.intesis.com/pdf/IntesisBox\\_Modbus\\_Server\\_Bacnet\\_IP\\_Client\\_datasheet\\_eng.pdf](http://www.intesis.com/pdf/IntesisBox_Modbus_Server_Bacnet_IP_Client_datasheet_eng.pdf)

### Main features

- Easy installation. Connection to the BACnet/IP network through Ethernet.
- Great integration flexibility. IntesisBox® IBOX-KNX-BAC is a BACnet/IP client that reads/writes points of other BACnet/IP devices, using continuous polling or subscription (COV). Supports both ModBus TCP or RTU (RS232 or RS485). ModBus registers are configured by supplied software LinkBoxMB.
- Advanced integration for centralized AC systems equipped with BACnet/IP interfaces, as Daikin, Mitsubishi Heavy, LG, etc. also integrating fan-coil controllers, meters, PLC's, HMI, etc.

# IBOX-MBS-BACMSTP

IntesisBox® IBOX-MBS-BACMSTP gateway have been specially designed, to allow monitoring and bidirectional control of all the parameters and functionality of systems and devices with BACnet/MSTP connectivity from ModBus installations.

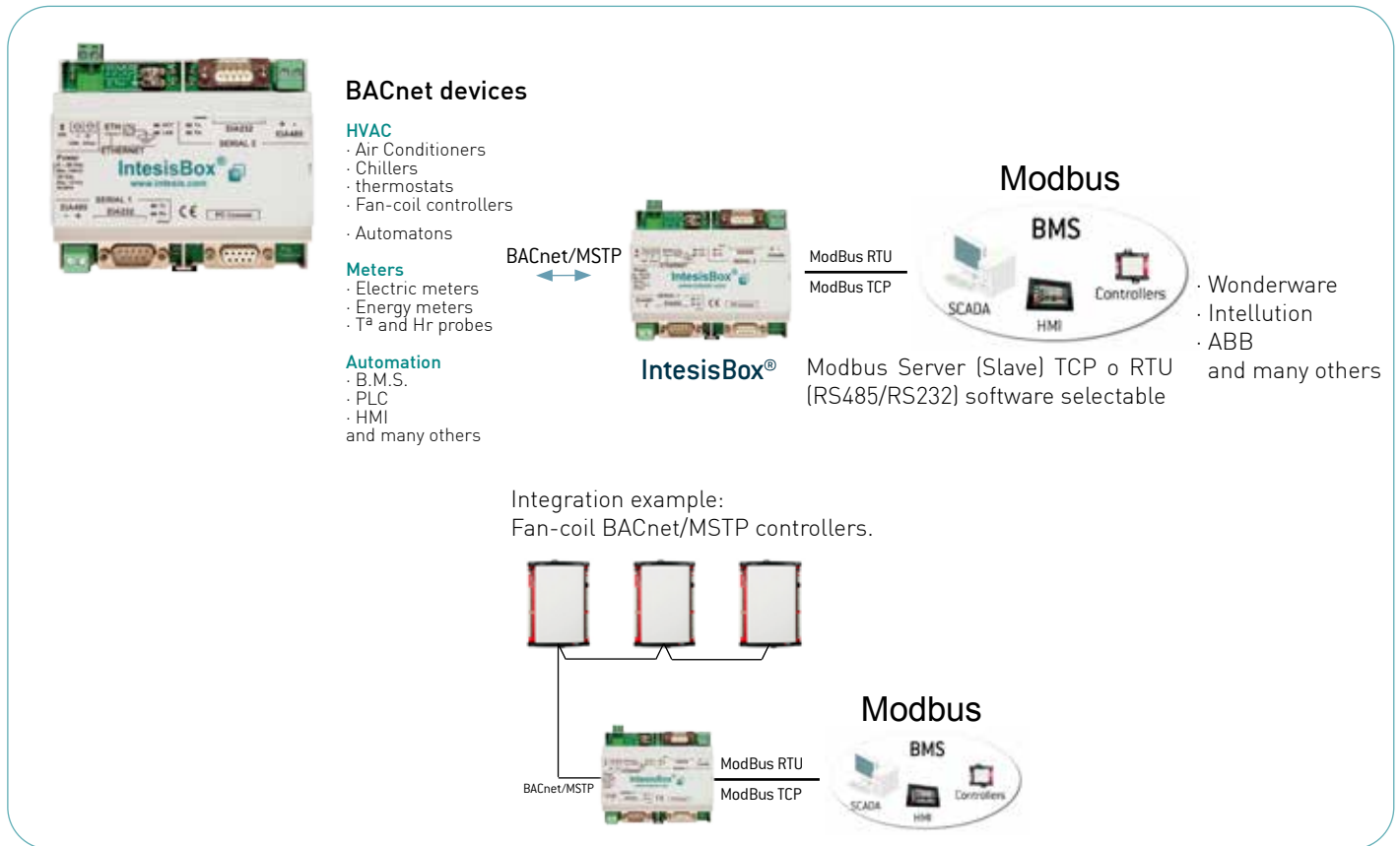

## Specifications

- Bidirectional: Monitoring and Control
- Robust and reliable hardware
- Direct connection to BACnet and ModBus
- Independent management of communications
- Power supply: 9 to 24Vdc or 24Vac
- Standard DIN-Rail 6 modules enclosure

## Models available

- IBOX-MBS-BACMSTP-100 (100 control points and 64 BACnet/MSTP devices)
- IBOX-MBS-BACMSTP-A (500 control points and 64 BACnet/MSTP devices)
- IBOX-MBS-BACMSTP-B (3000 control points and 64 BACnet/MSTP devices)

## Info

Datasheet: [http://www.intesis.com/pdf/IntesisBox\\_Modbus\\_Server\\_BACnet\\_MSTP\\_datasheet\\_eng.pdf](http://www.intesis.com/pdf/IntesisBox_Modbus_Server_BACnet_MSTP_datasheet_eng.pdf)

## Main features

- Easy installation. Direct connection using RS485 (2 wires) to BACnet devices.
- Great integration flexibility. IntesisBox® IBOX-KNX-BACMSTP is a BACnet/IP client that reads/writes points of other BACnet/SMTTP devices connected, using continuous polling or subscription (COV). Supports both ModBus TCP or RTU (RS232 or RS485). ModBus registers are configured by supplied software LinkBoxMB.
- Advanced integration of fan-coil controllers, meters, PLC's, HMI, etc.

## IBOX-KNX-BAC

IntesisBox® IBOX-KNX-BAC gateway has been specially designed to allow monitoring and bidirectional control of all the parameters and functionality of systems and equipment with BACnet/IP connectivity from KNX installations.

### BACnet devices

#### HVAC

- Air conditioners
- Coolers
- thermostats
- Fan-coil Controllers

#### Meters

- Electric meters
- Energy meters
- T° and Hr Probes

#### Automation

- B.M.S.
- PLC
- HMI

and many others

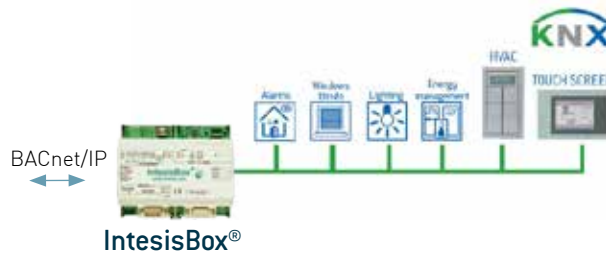

Integration example:

VRV DAIKIN Air conditioners equipped with BACnet gateway.



Integration example:

BACnet/IP Controllers.



### Specifications

- Bidirectional: Monitoring and Control
- Robust and reliable hardware
- Direct connection to KNX bus
- Independent management of communications
- Power supply: 9 to 24Vdc or 24Vac
- Standard DIN-Rail 6 modules enclosure

### Models available

- IBOX-KNX-BAC-100 (Maximum 100 control points and 16 BACnet/IP devices)
- IBOX-KNX-BAC-A (Maximum 500 control points and 16 BACnet/IP devices)
- IBOX-KNX-BAC-B (Maximum 4000 control points and 16 BACnet/IP devices)

### Info

Datasheet: [http://www.intesis.com/pdf/IntesisBox\\_KNX\\_Bacnet\\_IP\\_Client\\_datasheet\\_eng.pdf](http://www.intesis.com/pdf/IntesisBox_KNX_Bacnet_IP_Client_datasheet_eng.pdf)

### Main features

- Easy installation. Direct connection to the BACnet/IP network.
- Great integration flexibility. IntesisBox® IBOX-KNX-BAC is a BACnet/IP client that reads/writes points of other BACnet/IP devices. Read values kept in IntesisBox® memory to be used when needed by the KNX system.
- Advanced integration for centralized AC systems equipped with BACnet/IP interfaces, including meters, PLC's, HMI etc.



# IBOX-ASCII-BAC

IntesisBox® IBOX-ASCII-BAC gateway have been specially designed to allow monitoring and bidirectional control of BACnet/IP systems using simple text (ASCII) messages.

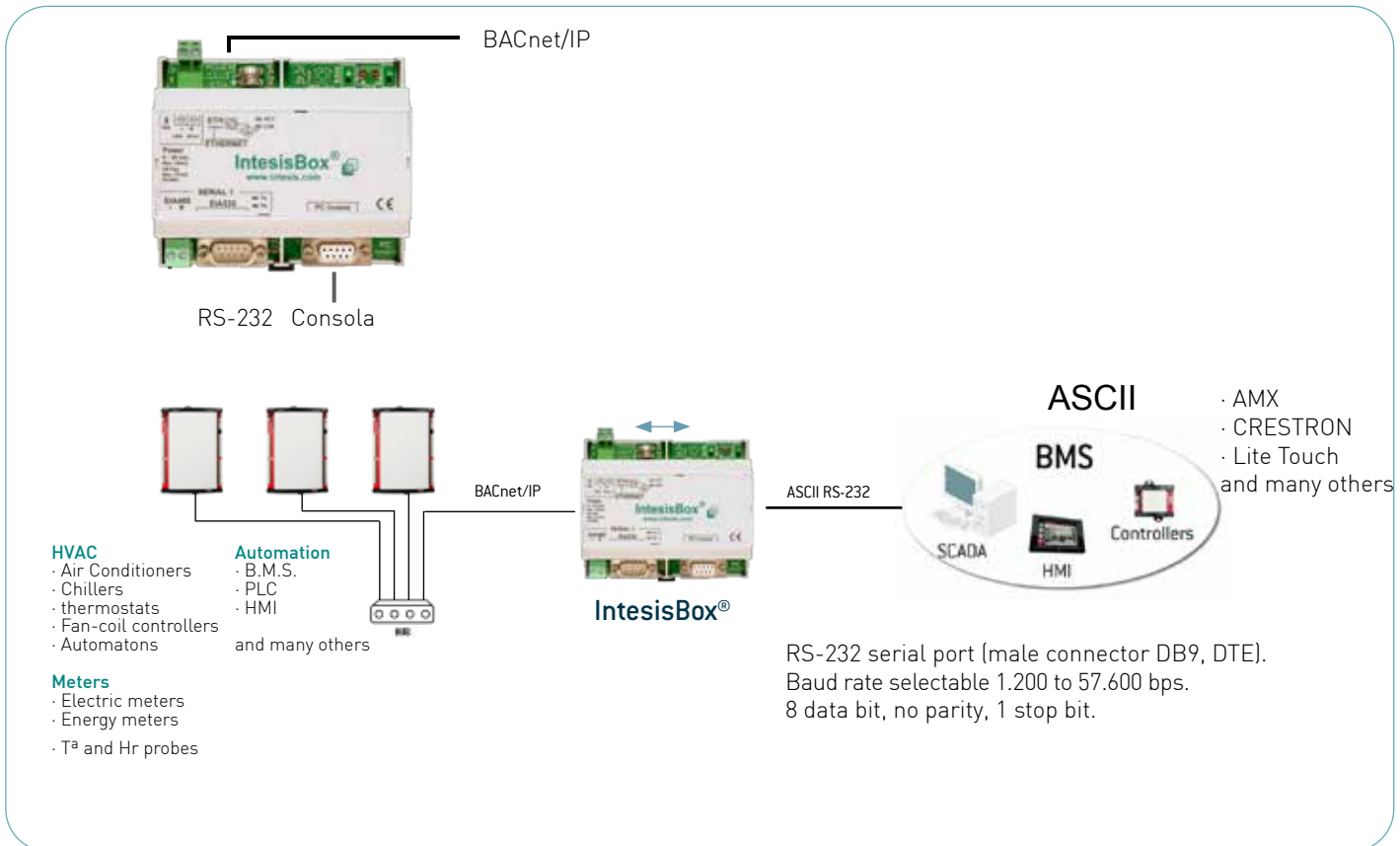

## Specifications

- Bidirectional: Monitoring and Control
- Robust and reliable hardware
- Direct connection to BACnet/IP network
- Independent management of communications
- Power supply: 9 to 24Vdc or 24Vac
- Standard DIN-Rail 6 modules enclosure

## Models available

- IBOX-ASCII-BAC-A (Maximum 500 control points and 64 BACnet/IP devices)
- IBOX-ASCII-BAC-B (Maximum 4000 control points and 64 BACnet/IP devices)

## Info

Datasheet: [http://www.intesis.com/pdf/IntesisBox\\_ASCII\\_Server\\_Bacnet\\_IP\\_Client\\_datasheet\\_eng.pdf](http://www.intesis.com/pdf/IntesisBox_ASCII_Server_Bacnet_IP_Client_datasheet_eng.pdf)

## Main features

- Easy installation.
- Great integration flexibility. The IntesisBox gateway can read other BACnet devices using continuous polling or subscription (COV). BACnet/IP objects can be read/write easily from the ASCII side, using simple text messages. Spontaneous messages can be sent to ASCII side when value changes are detected, avoiding to perform continuous polling. Configured by supplied software LinkBoxBAC.
- Advanced integration. Full transparent integration of BACnet devices in BMS systems based in ASCII like AMX, Crestron, Lite Touch, etc.

# Intesis

your partner for **systems integration**



C/ Milà i Fontanals, 1 bis 1º. 08700 Igualada · Barcelona · Spain  
Tel. +34 93 804 71 34 · Fax. +34 93 804 71 35 · sales@intesis.com

[www.intesis.com](http://www.intesis.com)



Authorized Dealer



Intesis Software is member of the KNX Association , KNX Spain and EnOcean Alliance

